

Influence of intermolecular interactions on magnetic observables

Jürgen Schnack^{1,*}

¹*Fakultät für Physik, Universität Bielefeld, Postfach 100131, D-33501 Bielefeld, Germany*

(Dated: November 13, 2015)

Very often it is an implied paradigm of molecular magnetism that magnetic molecules in a crystal interact so weakly that measurements of dc magnetic observables reflect ensemble properties of single molecules. But the number of cases where the assumption of virtually non-interacting molecules does not hold grows steadily. A deviation from the non-interacting case can especially clearly be seen in clusters with antiferromagnetic couplings, where steps of the low-temperature magnetization curve are smeared out with increasing intermolecular interaction. In this investigation we demonstrate with examples in one-, two, and three space dimensions how intermolecular interactions influence typical magnetic observables such as magnetization, susceptibility and specific heat.

PACS numbers: 75.10.Jm,75.50.Xx,75.40.Mg

I. INTRODUCTION

The statement, that the assumption of non-interacting magnetic molecules constitutes a paradigm, is of course exaggerated. In the more specific scientific community which deals with magnetic molecules for quantum computing the question of intermolecular (and other unwanted) interactions is of course of utmost importance.¹⁻⁷ Also in low-dimensional magnetism the question arises for instance in connection with dimerization or interchain as well as interlattice interactions.⁸⁻²¹ Intermolecular exchange is also carefully taken care of when designing magnetic multi-qubit devices. For these cases the intermolecular interactions are even made switchable.²⁰

In this paper we would like to approach the problem from a somewhat different perspective. We would like to ask how big intermolecular interactions have to be in order to modify dc magnetic observables so drastically that the fingerprint of the underlying molecular subunits is masked. We concentrate our investigations on molecules with an antiferromagnetic intramolecular coupling. For these cases the low-temperature magnetization curves consist of clearly spaced steps,²² which disappear with increasing antiferromagnetic intermolecular interaction. Such a behavior was observed in several recent investigations, compare e.g. Refs. 23–25, and interpreted in various ways. We don't offer a solution to specific problems, but we would like to present order-of-magnitude calculations that show for which ratios of inter- and intramolecular interactions magnetization steps of finite clusters disappear. We demonstrate that the space dimension of the embedding plays a strong role.

The evaluation of magnetic properties of interacting magnetic molecules constitutes a massive quantum many-body problem, even if only spin Hamiltonians are considered. That's why only two to three dozens of spins $s = 1/2$ can be modeled numerically exactly by diagonalizing a spin Hamiltonian even when symmetries are employed.²⁶⁻³⁵ But for non-frustrated spin systems quantum Monte Carlo³⁶⁻³⁸ (QMC) provides quasi exact ther-

modynamic observables. We therefore restrict our investigations to a series of such systems, which should be sufficient for the purpose of this paper. The clear advantage is that we do not rely on mean field approximations.^{9,11,39}

The result of our investigations is that single molecule signatures are washed out in the magnetization if the intermolecular interactions are stronger than about 10 % of the intramolecular interactions. The specific value depends on the space dimension of the embedding, e.g. for intermolecular interactions in three dimensions a smaller intermolecular interaction is needed to mask the molecular behavior than in lower dimensions. We compare some of our results with the scenario of J-strain, that sometimes is also taken into consideration for the interpretation of experimental data.

Finally, we would like to draw the readers attention to related investigations. An important related problem is given by the influence of interchain or interplane interactions on magnetic observables and in particular ordering temperatures in antiferromagnetic systems. Such questions are also dealt with by means of QMC for instance in Refs. 14, 16, and 19. Random-exchange quantum Heisenberg antiferromagnets on a square lattice have been investigated by QMC in Ref. 40. The influence of the embedding medium on ground state properties of a Heisenberg star system was investigated in Ref. 41.

The article is organized as follows. In Section II the theoretical framework is explained. Section III presents magnetization, susceptibility and specific heat for dimers, squares and cubes embedded in one, two and three dimensions, respectively, whereas Section IV discusses the magnetism of dimers with intermolecular interactions in one, two and three dimensions. In Section V a comparison with the scenario of J-strain is presented. The article closes with summary and outlook.

II. HAMILTONIAN AND CALCULATIONAL SCHEME

The investigated spin systems are modeled by a Heisenberg Hamiltonian augmented with a Zeeman term, i. e.

$$\tilde{H} = - \sum_{i < j} J_{ij} \vec{s}_i \cdot \vec{s}_j + g\mu_B B \sum_i s_i^z. \quad (1)$$

Thermodynamic observables are evaluated by means of quantum Monte Carlo^{36–38} (QMC) using the ALPS package.^{42,43} The prefactors in (1) are chosen according to the convention used in ALPS, in particular a negative Heisenberg exchange corresponds to an antiferromagnetic interaction. Without loss of generality $s = 1/2$ is chosen as spin quantum number, and the spectroscopic splitting factor is taken as $g = 2$ for all spins.

In our QMC calculations we choose $N = 100$ for one-dimensional problems, $N = 10 \times 10$ for two-dimensional problems as well as $N = 10 \times 10 \times 10$ for three-dimensional problems. In all cases periodic boundary conditions are applied. For magnetization curves we use 100000 steps for thermalization and another 100000 steps for sampling. In case of susceptibility and specific heat functions of temperature at $B = 0$ thermalization is done with 10000000 steps and sampling with 200000000 steps. Although we used $\epsilon = 0.1$ for the latter functions, convergence was very slow at the lowest temperatures, which can be seen in the upcoming plots. Fortunately, this does not alter our conclusions.

III. MAGNETIC OBSERVABLES FOR ONE-, TWO-, AND THREE-DIMENSIONAL INTERMOLECULAR INTERACTIONS

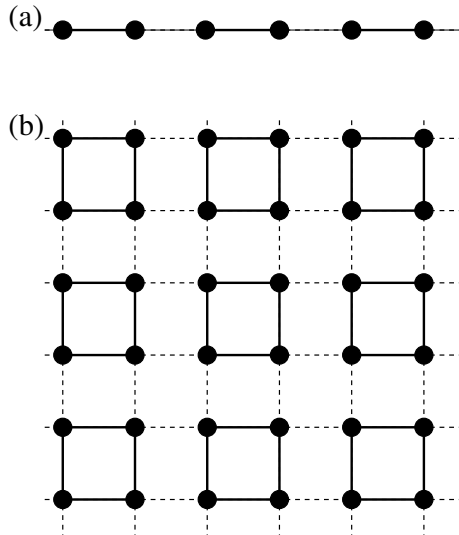

FIG. 1. (Color online) Schematic structure of the one-dimensional (a) and the two-dimensional bipartite lattice; solid bonds depict interactions J_1 , dashed bonds J_2 .

In the following magnetic observables are presented for small magnetic units (molecules) that are investigated in dependence of the intermolecular interaction. These investigations have been performed for couplings in one, two and three space dimensions. Our main concern is the magnetization curve, since this curve usually exhibits a very strong dependence on whether and how subunits are magnetically coupled.²² For small systems the magnetization curve exhibits clear fingerprints of the specific unit, such as magnetization steps.

We follow two rationals when comparing the behavior in different space dimensions. In the first investigation each spin interacts with the same number of intramolecular J_1 and intermolecular J_2 bonds with its neighbors. This is realized by dimers in one, squares in two and cubes in three dimensions. In addition, the size of the singlet-triplet gap is the same for dimer and square and almost the same (80 %) for the cube. In a second investigation the molecular unit is kept fixed as dimers, and the dimension of the embedding is varied.

A. One-dimensional system

One-dimensional systems have been very thoroughly investigated over almost a century. The famous Bethe ansatz for the spin-1/2 Heisenberg chain and the resulting knowledge on observables as well as the Haldane conjecture are cornerstones of this research.^{44–51} Here we focus on the question how magnetic observables develop with an increasing intermolecular interaction J_2 between dimers that are coupled through J_1 , compare Fig. 1 (a). Both interactions are antiferromagnetic. Since we deal with four quantities, J_1 , J_2 , T , and B , we decided to assume some reasonable values throughout the article that are common to materials in molecular magnetism, in particular we choose $J_1 = -10$ K.⁵² In some sense this investigation touches earlier works on dimerized (or spin-Peierls) spin chains,^{53–56} which investigate similar structures as Fig. 1 (a) but usually for a fixed ratio of interactions J_2/J_1 or some small interval of this ratio.

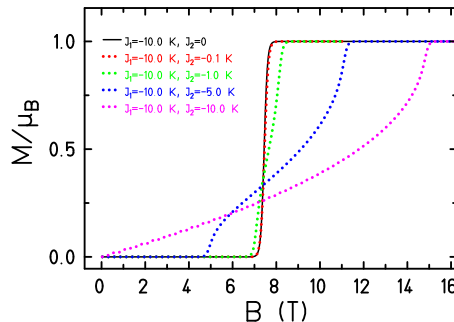

FIG. 2. (Color online) Low-temperature magnetization of the one-dimensional spin system shown in Fig. 1 (a) for various interdimer couplings J_2 and $T = 0.1$ K.

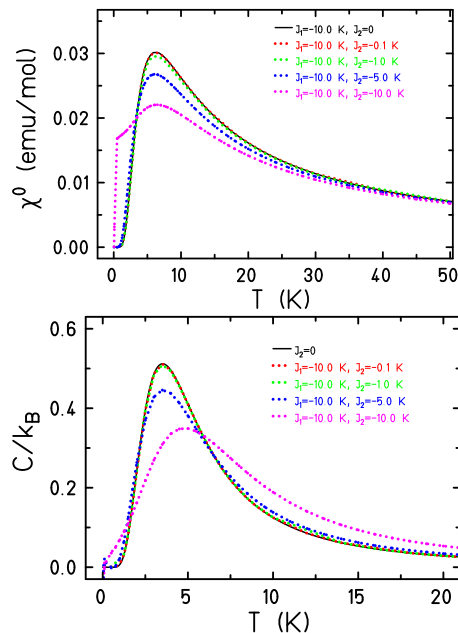

FIG. 3. (Color online) Zero-field susceptibility and specific heat of the one-dimensional spin system shown in Fig. 1 (a) for various interdimer couplings J_2 and $B = 0$. Fluctuations of C at the lowest T result from very slow and thus insufficient convergence.

For vanishing interdimer interaction $J_2 = 0$ the magnetization curve at low temperatures features one jump to saturation at the external field where the singlet and the lowest triplet level cross. This simple magnetization curve is characteristic for the af dimer of two spins $s = 1/2$. The jump is rather stable against an increase of J_2 ; even at $J_2/J_1 = 0.5$ the curve still warps around the former jump. For $J_2/J_1 = 1$ the limit of the af Heisenberg chain is reached, which results in a gapless continuous rise of the magnetization with increasing field.

The robustness of the dimer properties is also reflected in the susceptibility as well as specific heat functions, here in zero field. Both functions do not change their dimer character up to at least $J_2/J_1 = 0.5$. For $J_2/J_1 = 1$ they assume their characteristic behavior known from the Bethe ansatz: the system is gapless, and the specific heat shows Luttinger liquid behavior, i.e. grows linearly with T for low temperatures.

B. Two-dimensional system

For the investigations in two dimensions we chose a square as the unperturbed molecular system. The structure is shown in Fig. 1 (b). A Heisenberg square with af interaction shows two steps in the magnetization at fields B_1 and B_2 where the lowest triplet crosses the singlet and where the lowest pentet crosses the lowest triplet. This is clearly visible in Fig. 4 (black solid curve).

With increasing ratio J_2/J_1 the step-like structure is

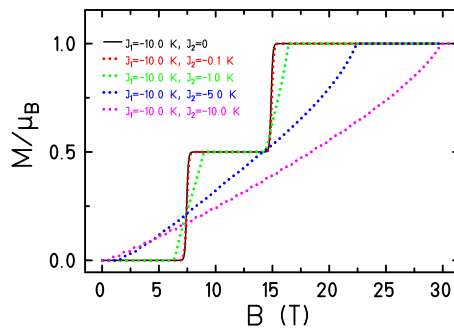

FIG. 4. (Color online) Low-temperature magnetization of the two-dimensional spin system shown in Fig. 1 (b) for various interdimer couplings J_2 and $T = 0.1$ K.

more quickly destroyed by the intermolecular interactions compared to the one-dimensional case. For $J_2/J_1 = 0.1$ the curve still warps around the former jumps, but for $J_2/J_1 = 0.5$ it is already almost continuous and in its character not much different from the magnetization curve of the af square lattice.^{57–59} This behavior is not so clearly reflected by the thermal functions. These are again rather stable against variations of J_2/J_1 , only the susceptibility displays the change by a very different rise at low-temperature. The specific heat does not display any feature since no ordering can occur in one or two dimensions for non-zero temperature.⁶⁰

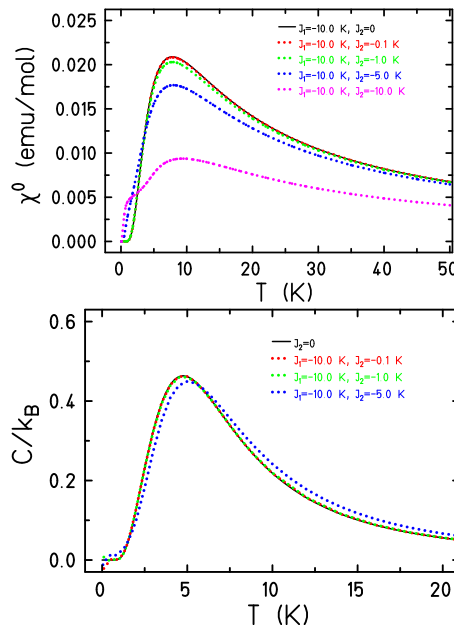

FIG. 5. (Color online) Zero-field susceptibility and specific heat of the two-dimensional spin system shown in Fig. 1 (b) for various interdimer couplings J_2 and $B = 0$.

C. Three-dimensional system

For the three-dimensional case we choose a simple cubic lattice where the molecular unit is given by cubes as sketched in Fig. 6. An isolated cube of spins $s = 1/2$ and af bonds along the edges shows four magnetization steps at low temperature which result from the successive level crossings of the lowest states with total spin $S = 0, 1, 2, 3, 4$. The simple cubic lattice with $J_2/J_1 = 1$ on the other hand is a system with long range order at $T > 0$, a property which the lower dimensional systems did not show in accordance with the theorem of Mermin and Wagner.⁶⁰

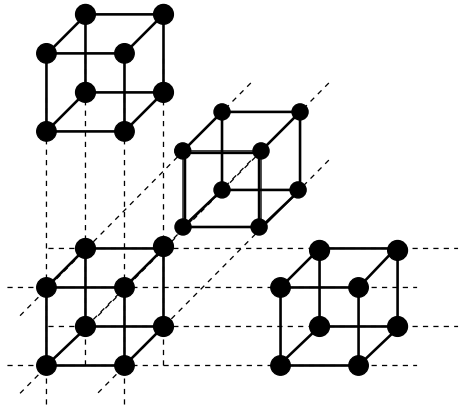

FIG. 6. Schematic structure of the investigated three-dimensional bipartite lattice; solid bonds depict interactions J_1 , dashed bonds J_2 .

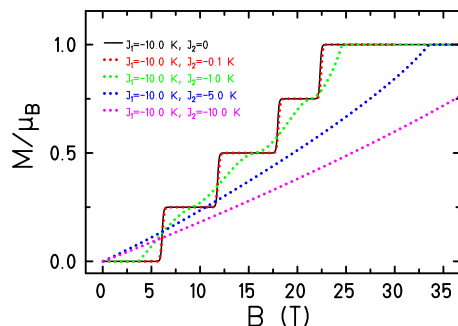

FIG. 7. (Color online) Low-temperature magnetization of the three-dimensional spin system shown in Fig. 6 for various interdimer couplings J_2 and $T = 0.1$ K.

Looking at the magnetization in Fig. 7 one immediately realizes that already a rather small intermolecular interaction of 10 % suffices to wash out the magnetization steps of the spin cube. It is important to keep in mind that the cube has almost the same singlet-triplet gap as dimer and square, so the effect is not thermal. We thus speculate that the dimensionality of the embedding structure, here three, is responsible for the quick disappearance of the molecular fingerprints with increasing intermolecular interaction.

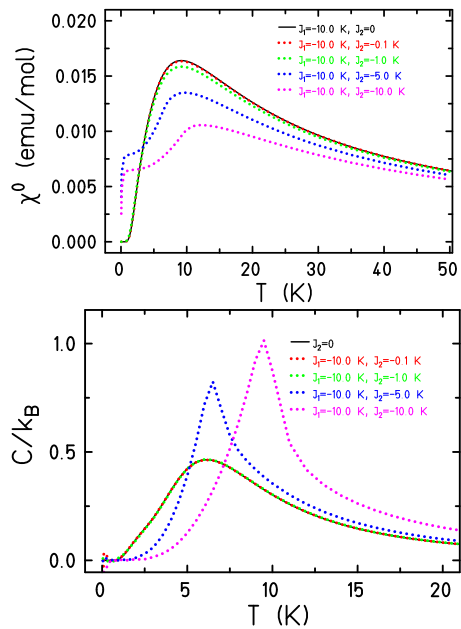

FIG. 8. (Color online) Zero-field susceptibility and specific heat of the three-dimensional spin system shown in Fig. 6 for various interdimer couplings J_2 and $B = 0$.

Although the magnetization is already drastically altered by 10 % intermolecular interactions, the temperature dependence of the susceptibility does not show much deviation in this case, compare Fig. 8. The same holds for the specific heat. These functions are modified only for larger intermolecular interactions in accord with the one- and two-dimensional cases. The peaks of the specific heat for $J_2/J_1 = 0.5$ and $J_2/J_1 = 1.0$ mark phase transitions to three-dimensional ordered phases – they correspond exactly to those shown in Ref. 14.

IV. DIMERS IN VARIOUS DIMENSIONS

In a second setup we kept the molecular unit fixed as a dimer and varied the dimension of the embedding. The one-dimensional case remains the same. The two-dimensional case can be derived from Fig. 1 (b) by replacing all (thick) vertical J_1 -bonds by (dashed) J_2 -bonds. For the three-dimensional case the two-dimensional lattices are stacked on top of each other with J_2 -bonds in between. Thus each spin is connected by one J_1 -bond and one, three, and five J_2 -bonds for the one-, two-, and three-dimensional case, respectively.

For the following investigation $J_2/J_1 = 0.1$ as well as the temperature were kept constant. As can be clearly seen in Fig. 9 the magnetization step is more strongly washed out with increasing dimensionality. The influence on the temperature dependence of both susceptibility as well as specific heat is again weak, see Fig. 10.

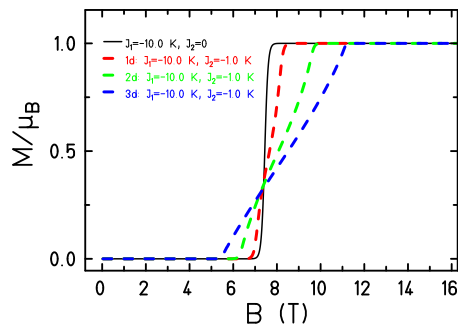

FIG. 9. (Color online) Low-temperature magnetization of dimers in one-, two and three-dimensional arrangements for $J_2 = 1.0$ K and $T = 0.1$ K.

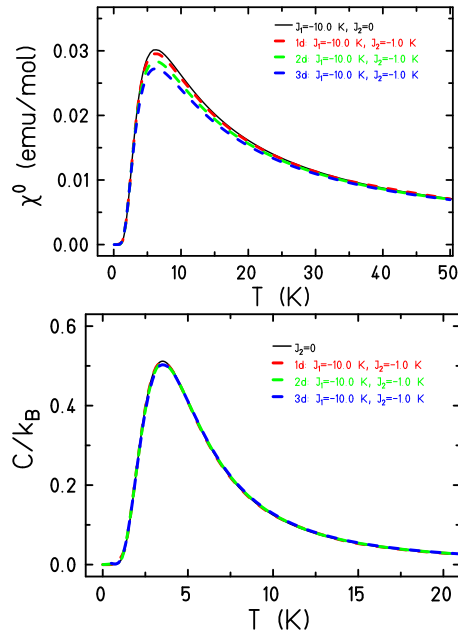

FIG. 10. (Color online) Zero-field susceptibility and specific heat of dimers in one-, two and three-dimensional arrangements for $J_2 = 1.0$ K and $T = 0.1$ K.

V. COMPARISON WITH J-STRAIN

Finally, as a supplement to the presented investigations, we would like to discuss the question whether a similar modification of observables could stem from J-strain. The assumption of strain, for instance g-strain, is not unusual for instance when modeling EPR lines. J-strain, i.e. a distribution of J values about a mean was used in several theoretical models, see e.g. Refs. 23, 25, and 61. The effect of J-strain is rather similar to that of intermolecular interactions: magnetization steps are smeared out, and susceptibility as well as specific heat as functions of temperature are not much altered.

In the following we present an investigation in which independent dimers with a flat distribution of J_1 -values

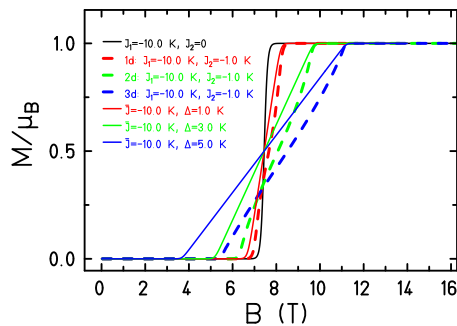

FIG. 11. (Color online) Low-temperature magnetization of dimers in one-, two and three-dimensional arrangements for $J_2 = 1.0$ K and $T = 0.1$ K (dashes) compared to isolated dimers with a J-strain of $\Delta = 1.0, 3.0, 5.0$ K (solid curves), respectively.

in the interval $[\bar{J} - \Delta, \bar{J} + \Delta]$ have been simulated. Δ was chosen such, that the saturation field for the three cases discussed in section IV is met. Figure 11 shows a comparison of the magnetization of a single dimer (black solid curve), of dimers with intermolecular interactions in one, two, and three space dimensions (dashed curves) as well as of dimers with J-strain according to the flat distribution (solid colored curves). One immediately realizes that the functional form of the magnetization curve with J-strain is different from the behavior under the influence of intermolecular interactions. Although the saturation field is met by tuning Δ appropriately, the onset of the magnetization curves happens already at smaller fields. In addition, at the field value where the magnetization step happens for the unperturbed dimer, the magnetization curves of dimers with J-strain cross at half the step height whereas for intermolecular interactions the magnetization curves cross at a lower magnetization. Overall, the magnetization curves for J-strain are symmetric about the crossing field value. This would also hold if another (more realistic, but also symmetric about \bar{J}) Gaussian distribution of J_1 values would have been taken. Intermolecular interactions on the contrary seem to lead to magnetization curves, that do not show any symmetry with respect to the original crossing field.

Figure 12 demonstrates that somewhat contrary to the findings of section IV now the susceptibility is only very weakly altered whereas the specific heat is more drastically modified especially for the case of the largest J-strain.

VI. SUMMARY AND OUTLOOK

We investigated the question how intermolecular interactions influence magnetic observables for small (molecular) magnetic units. In particular we investigated for certain bipartite configurations how large the intermolecular interaction needs to be compared to the intramolecular interaction in order to mask the molecular behavior.

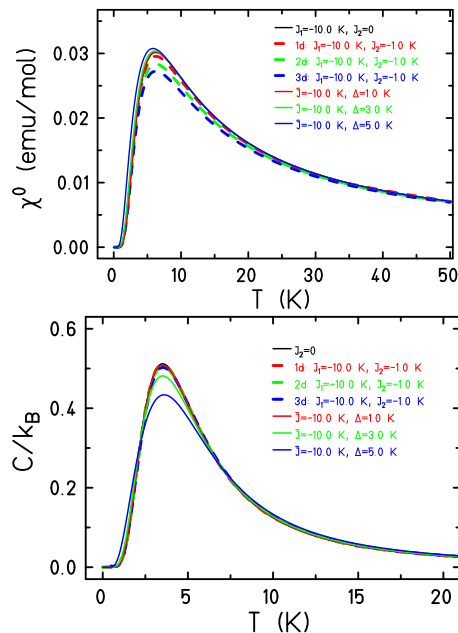

FIG. 12. (Color online) Zero-field susceptibility and specific heat of dimers in one-, two and three-dimensional arrangements for $J_2 = 1.0$ K and $T = 0.1$ K (dashes) compared to isolated dimers with a J-strain of $\Delta = 1.0, 3.0, 5.0$ K (solid curves), respectively.

It could be demonstrated that the various static magnetic observables reflect intermolecular interactions differently: the low-temperature magnetization turned out to be most sensitive, since the appearance of magnetization steps appears to be fragile. In addition dimensionality plays a role. With increasing space dimensionality of the intermolecular coupling the effect of masking molecular properties happens for smaller intermolecular coupling. Finally we discussed briefly whether similar modifications of observables could be misinterpreted as J-strain. We pointed out, that certain features of the observables are different in the two scenarios, so that with good quality of experimental data a discrimination should be possible.

ACKNOWLEDGMENT

This work was supported by the Deutsche Forschungsgemeinschaft (DFG SCHN 615/20-1). I would like to thank Arzhang Ardavan, Stephen Blundell, Marco Evangelisti, Andreas Honecker, Franziska Kirschner, Hiroyuki Nojiri and Johannes Richter for valuable discussions.

* jschnack@uni-bielefeld.de

- ¹ A. Ardavan, O. Rival, J. J. L. Morton, S. J. Blundell, A. M. Tyryshkin, G. A. Timco, and R. E. P. Winpenny, "Will Spin-Relaxation Times in Molecular Magnets Permit Quantum Information Processing?" *Phys. Rev. Lett.* **98**, 057201 (2007).
- ² A. Candini, G. Lorusso, F. Troiani, A. Ghirri, S. Carretta, P. Santini, G. Amoretti, C. Murny, F. Tuna, G. Timco, E. J. L. McInnes, R. E. P. Winpenny, W. Wernsdorfer, and M. Affronte, "Entanglement in Supramolecular Spin Systems of Two Weakly Coupled Antiferromagnetic Rings (Purple-Cr₇Ni)," *Phys. Rev. Lett.* **104**, 037203 (2010).
- ³ A. Chiesa, D. Gerace, F. Troiani, G. Amoretti, P. Santini, and S. Carretta, "Robustness of quantum gates with hybrid spin-photon qubits in superconducting resonators," *Phys. Rev. A* **89**, 052308 (2014).
- ⁴ E. M. Pineda, N. F. Chilton, R. Marx, M. Dörfel, D. O. Sells, P. Neugebauer, S.-D. Jiang, D. Collison, J. van Slageren, E. J. McInnes, and R. E. Winpenny, "Direct measurement of dysprosium(III)···dysprosium(III) interactions in a single-molecule magnet," *Nat. Commun.* **5**, 5243 (2014).
- ⁵ T. Lancaster, P. A. Goddard, S. J. Blundell, F. R. Foronda, S. Ghannadzadeh, J. S. Möller, P. J. Baker, F. L. Pratt, C. Baines, L. Huang, J. Wosnitza, R. D. McDonald, K. A. Modic, J. Singleton, C. V. Topping, T. A. W. Beale, F. Xiao, J. A. Schlueter, A. M. Barton, R. D. Cabrera, K. E. Carreiro, H. E. Tran, and J. L. Manson, "Controlling Magnetic Order and Quantum Disorder in Molecule-Based Magnets," *Phys. Rev. Lett.* **112**, 207201 (2014).
- ⁶ E. H. Lapasar, K. Kasamatsu, S. N. Chormaic, T. Takui, Y. Kondo, M. Nakahara, and T. Ohmi, "Two-Qubit Gate Operation on Selected Nearest-Neighbor Neutral Atom Qubits," *J. Phys. Soc. Jpn.* **83**, 044005 (2014).
- ⁷ S. Yamamoto, S. Nakazawa, K. Sugisaki, K. Sato, K. Toyota, D. Shiomi, and T. Takui, "Adiabatic quantum computing with spin qubits hosted by molecules," *Phys. Chem. Chem. Phys.* **17**, 2742 (2015).
- ⁸ T. Oguchi, "Exchange Interactions in Cu(NH₃)₄SO₄·H₂O," *Phys. Rev.* **133**, A1098 (1964).
- ⁹ M. Tachiki and T. Yamada, "Spin Ordering in a Spin-Pair System," *J. Phys. Soc. Jpn.* **28**, 1413 (1970).
- ¹⁰ M. Tachiki, T. Yamada, and S. Maekawa, "Short Range Order of Spins in Cu(NO₃)₂·2.5H₂O under Magnetic Field," *J. Phys. Soc. Jpn.* **29**, 663 (1970).
- ¹¹ T. Oguchi and M. Blume, "Theory of the Field Dependence of the Neel Temperature in Quasi One-Dimensional Antiferromagnets," *J. Phys. Soc. Jpn.* **50**, 2547 (1981).
- ¹² Y. Nakazawa, M. Tamura, N. Shirakawa, D. Shiomi, M. Takahashi, M. Kinoshita, and M. Ishikawa, "Low-temperature magnetic properties of the ferromagnetic organic radical, *p*-nitrophenyl nitronyl nitroxide," *Phys. Rev. B* **46**, 8906 (1992).
- ¹³ K. Kodama, M. Takigawa, M. Horvatic, C. Berthier, H. Kageyama, Y. Ueda, S. Miyahara, F. Becca, and F. Mila, "Magnetic Superstructure in the Two-Dimensional Quantum Antiferromagnet SrCu₂(BO₃)₂," *Science* **298**, 395 (2002).
- ¹⁴ P. Sengupta, A. W. Sandvik, and R. R. P. Singh, "Specific heat of quasi-two-dimensional antiferromagnetic Heisenberg models with varying interplanar couplings," *Phys.*

- Rev. B **68**, 094423 (2003).
- 15 D. Schmalfuß, J. Richter, and D. Ihle, "Green's function theory of quasi-two-dimensional spin-half Heisenberg ferromagnets: Stacked square versus stacked kagomé lattices," *Phys. Rev. B* **72**, 224405 (2005).
 - 16 C. Yasuda, S. Todo, K. Hukushima, F. Alet, M. Keller, M. Troyer, and H. Takayama, "Néel Temperature of Quasi-Low-Dimensional Heisenberg Antiferromagnets," *Phys. Rev. Lett.* **94**, 217201 (2005).
 - 17 L. Lecren, W. Wernsdorfer, Y.-G. Li, A. Vindigni, H. Miyasaka, and R. Clerac, "One-Dimensional Supramolecular Organization of Single-Molecule Magnets," *J. Am. Chem. Soc.* **129**, 5045 (2007).
 - 18 F.-M. Nie, S. Demeshko, S. Fuchs, S. Dechert, T. Pruschke, and F. Meyer, "Targeted self-assembly and quantum Monte Carlo magnetic study of an alternating nickel(ii) 1D coordination polymer composed of highly pre-organized binuclear tectons," *Dalton Trans.*, 3971 (2008).
 - 19 R. T. Butcher, C. P. Landee, M. M. Turnbull, and F. Xiao, "Rectangular two-dimensional antiferromagnetic systems: Analysis of copper(II) pyrazine dibromide and dichloride," *Inorg. Chim. Acta* **361**, 3654 (2008).
 - 20 M. Morimoto, H. Miyasaka, M. Yamashita, and M. Irie, "Coordination Assemblies of [Mn4] Single-Molecule Magnets Linked by Photochromic Ligands: Photochemical Control of the Magnetic Properties," *J. Am. Chem. Soc.* **131**, 9823 (2009).
 - 21 Y. C. Arango, E. Vavilova, M. Abdel-Hafez, O. Jansson, A. A. Tsirlin, H. Rosner, S.-L. Drechsler, M. Weil, G. Nénert, R. Klingeler, O. Volkova, A. Vasiliev, V. Kataev, and B. Büchner, "Magnetic properties of the low-dimensional spin- $\frac{1}{2}$ magnet α -Cu₂As₂O₇," *Phys. Rev. B* **84**, 134430 (2011).
 - 22 Y. Shapira and V. Bindilatti, "Magnetization-step studies of antiferromagnetic clusters and single ions: Exchange, anisotropy, and statistics," *J. Appl. Phys.* **92**, 4155 (2002).
 - 23 C. Schröder, R. Prozorov, P. Kögerler, M. D. Vannette, X. Fang, M. Luban, A. Matsuo, K. Kindo, A. Müller, and A. M. Todea, "Multiple nearest-neighbor exchange model for the frustrated magnetic molecules {Mo₇₂Fe₃₀} and {Mo₇₂Cr₃₀}," *Phys. Rev. B* **77**, 224409 (2008).
 - 24 I. A. Kühne, G. E. Kostakis, C. E. Anson, and A. K. Powell, "A magnetically highly frustrated Cu₂₇^{II} coordination cluster containing a Cu₁₈ folded-sheet motif," *Chem. Commun.* **51**, 2702 (2015).
 - 25 M. A. Palacios, E. M. Pineda, S. Sanz, R. Inglis, M. B. Pitak, S. J. Coles, M. Evangelisti, H. Nojiri, C. Heesing, E. K. Brechin, J. Schnack, and R. E. P. Winpenny, "Copper Keplerates: High Symmetry Magnetic Molecules," *ChemPhysChem* (2015), 10.1002/cphc.201500956, in print.
 - 26 C. Delfs, D. Gatteschi, L. Pardi, R. Sessoli, K. Wieghardt, and D. Hanke, "Magnetic properties of an octanuclear iron(III) cation," *Inorg. Chem.* **32**, 3099 (1993).
 - 27 D. Gatteschi and L. Pardi, "Magnetic-properties of high-nuclearity spin clusters - a fast and efficient procedure for the calculation of the energy-levels," *Gazz. Chim. Ital.* **123**, 231 (1993).
 - 28 J. J. Borrás-Almenar, J. M. Clemente-Juan, E. Coronado, and B. S. Tsukerblat, "High-nuclearity magnetic clusters: Generalized spin Hamiltonian and its use for the calculation of the energy levels, bulk magnetic properties, and inelastic neutron scattering spectra," *Inorg. Chem.* **38**, 6081 (1999).
 - 29 A. Bencini and D. Gatteschi, *Electron paramagnetic resonance of exchange coupled systems* (Springer, Berlin, Heidelberg, 1990).
 - 30 B. S. Tsukerblat, *Group theory in chemistry and spectroscopy: a simple guide to advanced usage*, 2nd ed. (Dover Publications, Mineola, New York, 2006).
 - 31 O. Waldmann, "Symmetry and energy spectrum of high-nuclearity spin clusters," *Phys. Rev. B* **61**, 6138 (2000).
 - 32 B. Tsukerblat, "Group-theoretical approaches in molecular magnetism: Metal clusters," *Inorg. Chim. Acta* **361**, 3746 (2008).
 - 33 A. S. Boyarchenkov, I. G. Bostrem, and A. S. Ovchinnikov, "Quantum magnetization plateau and sign change of the magnetocaloric effect in a ferrimagnetic spin chain." *Phys. Rev. B* **76**, 224410 (2007).
 - 34 R. Schnalle and J. Schnack, "Numerically exact and approximate determination of energy eigenvalues for antiferromagnetic molecules using irreducible tensor operators and general point-group symmetries," *Phys. Rev. B* **79**, 104419 (2009).
 - 35 R. Schnalle and J. Schnack, "Calculating the energy spectra of magnetic molecules: application of real- and spin-space symmetries," *Int. Rev. Phys. Chem.* **29**, 403 (2010).
 - 36 A. W. Sandvik and J. Kurkijärvi, "Quantum Monte Carlo simulation method for spin systems," *Phys. Rev. B* **43**, 5950 (1991).
 - 37 A. W. Sandvik, "Stochastic series expansion method with operator-loop update," *Phys. Rev. B* **59**, R14157 (1999).
 - 38 O. F. Syljuåsen and A. W. Sandvik, "Quantum Monte Carlo with directed loops," *Phys. Rev. E* **66**, 046701 (2002).
 - 39 H. J. Schulz, "Dynamics of Coupled Quantum Spin Chains," *Phys. Rev. Lett.* **77**, 2790 (1996).
 - 40 N. Laflorencie, S. Wessel, A. Läuchli, and H. Rieger, "Random-exchange quantum Heisenberg antiferromagnets on a square lattice," *Phys. Rev. B* **73**, 060403 (2006).
 - 41 J. Richter, A. Voigt, S. E. Krüger, and C. Gros, "The spin-1/2 Heisenberg star with frustration: II. The influence of the embedding medium," *Journal of Physics A: Mathematical and General* **29**, 825 (1996).
 - 42 A. Albuquerque, F. Alet, P. Corboz, P. Dayal, A. Feiguin, S. Fuchs, L. Gamper, E. Gull, S. Gürtler, A. Honecker, R. Igarashi, M. Körner, A. Kozhevnikov, A. Läuchli, S. Manmana, M. Matsumoto, I. McCulloch, F. Michel, R. Noack, G. Pawłowski, L. Pollet, T. Pruschke, U. Schollwöck, S. Todo, S. Trebst, M. Troyer, P. Werner, and S. Wessel (ALPS collaboration), "The ALPS project release 1.3: Open-source software for strongly correlated systems," *J. Magn. Magn. Mater.* **310**, 1187 (2007).
 - 43 B. Bauer, L. D. Carr, H. G. Evertz, A. Feiguin, J. Freire, S. Fuchs, L. Gamper, J. Gukelberger, E. Gull, S. Guertler, A. Hehn, R. Igarashi, S. V. Isakov, D. Koop, P. N. Ma, P. Mates, H. Matsuo, O. Parcollet, G. Pawowski, J. D. Picon, L. Pollet, E. Santos, V. W. Scarola, U. Schollwöck, C. Silva, B. Surer, S. Todo, S. Trebst, M. Troyer, M. L. Wall, P. Werner, and S. Wessel, "The ALPS project release 2.0: open source software for strongly correlated systems," *J. Stat. Mech.: Theor. Exp.* **2011**, P05001 (2011).
 - 44 H. Bethe, "Zur Theorie der Metalle," *Z. Phys.* **71**, 205 (1931).
 - 45 L. Hulthén, "Über das Austauschproblem eines Kristalles," *Arkiv Mat. Astr. Fys. A* **26**, 106 (1938).

- ⁴⁶ R. B. Griffiths, "Magnetization Curve at Zero Temperature for the Antiferromagnetic Heisenberg Linear Chain," *Phys. Rev.* **133**, A768 (1964).
- ⁴⁷ F. Haldane, "Continuum dynamics of the 1-d Heisenberg anti-ferromagnet - identification with the $o(3)$ non-linear sigma-model," *Phys. Lett. A* **93**, 464 (1983).
- ⁴⁸ F. Haldane, "Non-linear field-theory of large-spin Heisenberg antiferromagnets - semi-classically quantized solitons of the onedimensional easy-axis neel state," *Phys. Rev. Lett.* **50**, 1153 (1983).
- ⁴⁹ I. Affleck and E. H. Lieb, "A proof of part of Haldane's conjecture on spin chains," *Lett. Math. Phys.* **12**, 57 (1986).
- ⁵⁰ I. Affleck, D. Gepner, H. Schulz, and T. Ziman, "Critical behaviour of spin- s Heisenberg antiferromagnetic chains: analytic and numerical results," *J. Phys. A* **22**, 511 (1989).
- ⁵¹ A. Klümper, "The spin-1/2 Heisenberg chain: thermodynamics, quantum criticality and spin-Peierls exponents," *Eur. Phys. J. B* **5**, 677 (1998).
- ⁵² The reader is of course free to make all quantities dimensionless, e.g. by dividing by J_1 .
- ⁵³ K. Hida, "Crossover between the Haldane-gap phase and the dimer phase in the spin-1/2 alternating Heisenberg chain," *Phys. Rev. B* **45**, 2207 (1992).
- ⁵⁴ L. P. Regnault, M. Aïn, B. Hennion, G. Dhalenne, and A. Revcolevschi, "Inelastic-neutron-scattering investigation of the spin-Peierls system CuGeO_3 ," *Phys. Rev. B* **53**, 5579 (1996).
- ⁵⁵ G. S. Uhrig and H. J. Schulz, "Magnetic excitation spectrum of dimerized antiferromagnetic chains," *Phys. Rev. B* **54**, R9624 (1996).
- ⁵⁶ Knetter, C. and Uhrig, G. S., "Perturbation theory by flow equations: dimerized and frustrated $s = 1/2$ chain," *Eur. Phys. J. B* **13**, 209 (2000).
- ⁵⁷ E. Manousakis, "The spin-1/2 Heisenberg antiferromagnet on a square lattice and its application to the cuprous oxides," *Rev. Mod. Phys.* **63**, 1 (1991).
- ⁵⁸ J. Richter, "Zero-temperature magnetic-ordering in the inhomogeneously frustrated quantum heisenberg-antiferromagnet on a square lattice," *Phys. Rev. B* **47**, 5794 (1993).
- ⁵⁹ A. W. Sandvik, "Finite-size scaling of the ground-state parameters of the two-dimensional Heisenberg model," *Phys. Rev. B* **56**, 11678 (1997).
- ⁶⁰ N. Mermin and H. Wagner, "Absence of ferromagnetism or antiferromagnetism in one- or two-dimensional isotropic Heisenberg models," *Phys. Rev. Lett.* **17**, 1133 (1966).
- ⁶¹ C. Schröder, X. Fang, Y. Furukawa, M. Luban, R. Prozorov, F. Borsa, and K. Kumagai, "Spin freezing and slow magnetization dynamics in geometrically frustrated magnetic molecules with exchange disorder," *J. Phys.: Condens. Matter* **22**, 216007 (2010).